

# SPECIFICATION

- Part No. : **MA220.LB.001**
- Product Name : Optimus MA220 2in1 GPS-GLONASS-GALILEO/  
LTE  
External Adhesive Antenna for Glass and  
Plastic Mount
- Features : GPS-GLONASS-GALILEO - High gain LNA up to 32dB  
4G LTE band – 698 MHz to 2700MHz  
Covers legacy worldwide 2G and 3G bands  
LTE/GSM/CDMA/PCS/DCS/UMTS/GPRS/EDGE/HSPA  
IP67  
Height 12mm Diameter 62.8mm  
**RoHS Compliant**



## 1. Introduction

The Optimus MA220 is a combination high performance GPS-GLONASS-GALILEO and 4G/3G/2G LTE (plus GSM /CDMA/PCS/DCS/UMTS/GPRS/EDGE/HSPA) antenna to simplify Automotive Telematic and Fleet management systems worldwide. Its high quality low profile covert housing can be attached onto the glass or even out of sight under the dashboard. This combination of a high gain GPS/GLONASS/GALILEO antenna and a LTE antenna is ideal for those applications that require durability, small size and covert installation, and reliable reception and transmission crossing through different mobile networks.

The LTE cellular antenna function covers all main LTE and 3G/2G cellular bands worldwide. It has been designed to work equally well when mounted on glass or on plastic. It is not suitable for mounting on metal.

The GPS/GLONASS/GALILEO function means increased accuracy and reliability of location. A front-end SAW protects the LNA from burnout by nearby out of band cellular transmissions and also significantly reduces any compression and consequent reduction of sensitivity.

The standard version has 3 metres RG174 cable and SMA(M) connector on both GPS/GLONASS/GALILEO and LTE. For even higher gain and efficiency we recommend if you can to use shorter cable lengths, as shown in the charts below. The cable lengths and connector types are completely customizable according to customer request, subject to a minimum order quantity.

The slim housing is fully IP67 waterproof. A separate automotive approved 3M adhesive pad is provided, allowing the antenna to be mounted correctly facing through glass, or directly onto a plastic surface like the dashboard of a vehicle.

Note if US LTE network certification is required contact Taoglas for advice on correct antenna choice.

## 1.1. Features

### GPS-GLONASS-GALILEO

- High LNA Gain up to 32 dB
- Antenna Gain  $30 \pm 2$  dB
- Low Noise 1.5 dB max

### LTE

- Advanced 4G LTE antenna with 3G/2G application bands included  
LTE/GSM/CDMA/PCS/DCS/UMTS/GPRS/EDGE/HSPA

### Other

- Ultrasonically Welded - Water Resistant IP 67
- UV Resistant
- Quality textured covert design. Low profile
- Comes with automotive approved high grade 3M double sided tape for quick and easy mounting
- Customizable cables and connectors

## 2. Specification

4G/3G/2G Antenna									
Frequency (MHz)	LTE 700	LTE Band 20	GSM 850	GSM 900	DCS	PCS	WCDMA I /UMTS	Wi-Fi	LTE 2600
	698 ~798	791 ~862	824 ~894	880 ~960	1710 ~1880	1850 ~1990	1920 ~2170	2400 ~2500	2570 ~2690
Free Space									
Peak Gain (dBi) *	-1.54	-0.53	-0.53	-1.07	-0.10	0.72	0.89	-2.40	-1.59
Average Gain (dBi) *	-7.21	-6.02	-5.71	-8.20	-6.46	-6.10	-5.99	-7.39	-7.40
Efficiency (%)*	19.12	25.29	27.38	16.20	22.62	24.62	25.22	18.27	18.21
On 2mm Thickness ABS									
Peak Gain (dBi) *	-1.13	-0.05	-0.05	-1.91	2.21	1.68	1.63	-3.36	-0.63
Average Gain (dBi) *	-6.72	-4.78	-5.01	-7.96	-6.01	-4.99	-5.73	-9.07	-7.64
Efficiency (%)*	21.66	33.32	31.52	16.59	25.37	31.75	28.06	12.36	17.21
On Glass									
Peak Gain (dBi) *	-0.71	-0.35	-0.35	-2.03	1.76	1.71	1.48	-2.94	-1.31
Average Gain (dBi) *	-6.44	-4.99	-5.36	-8.37	-5.76	-5.29	-6.18	-9.21	-8.04
Efficiency (%)*	23.01	31.79	29.03	14.93	26.78	29.61	25.07	11.97	15.70
Return loss (dB) *	< -5								
Polarization	Linear								
Impedance	50Ω								
Cable	3m RG174 standard, fully customizable								
Connector	SMA(M), standard, fully customizable								
Maximum Input Power	5W								

GPS-GLONASS-GALILEO	
Center Frequency	GPS/GALILEO:1575.42±3 MHz GLONASS:1602±0.5 MHz
Gain	3 ±1 dBic typ.
VSWR	1.92:1 Max
Impedance	50Ω
Antenna Patch Size	25x25x4mm
Cable	3m RG174 standard, fully customizable
Connector	SMA(M), standard, fully customizable
LNA Electrical Properties	
Center Frequency fc	GPS/GALILEO:1575.42±3 MHz GLONASS:1602±0.5 MHz
Impedance	50 Ω Nominal
VSWR	< 1.92:1
Return Loss	10 dB Min.
Gain	31 dB Min. @3.3V
DC Power Input	3.3V
Noise Figure @3.3V	1.5dB
Power Consumption	12mA

MECHANICAL	
Antenna Dimensions	62.8mm x 68mm x 12mm
Casing	ABS
Waterproof	IP67
ENVIRONMENTAL	
Operation Temperature	-40°C to 85°C
Storage Temperature	-40°C to 90°C
Humidity	Non-condensing 65°C 95% RH

\*note: includes 3 metre RG174 cable loss

### 3. LTE Antenna Characteristics

#### 3.1. Return Loss

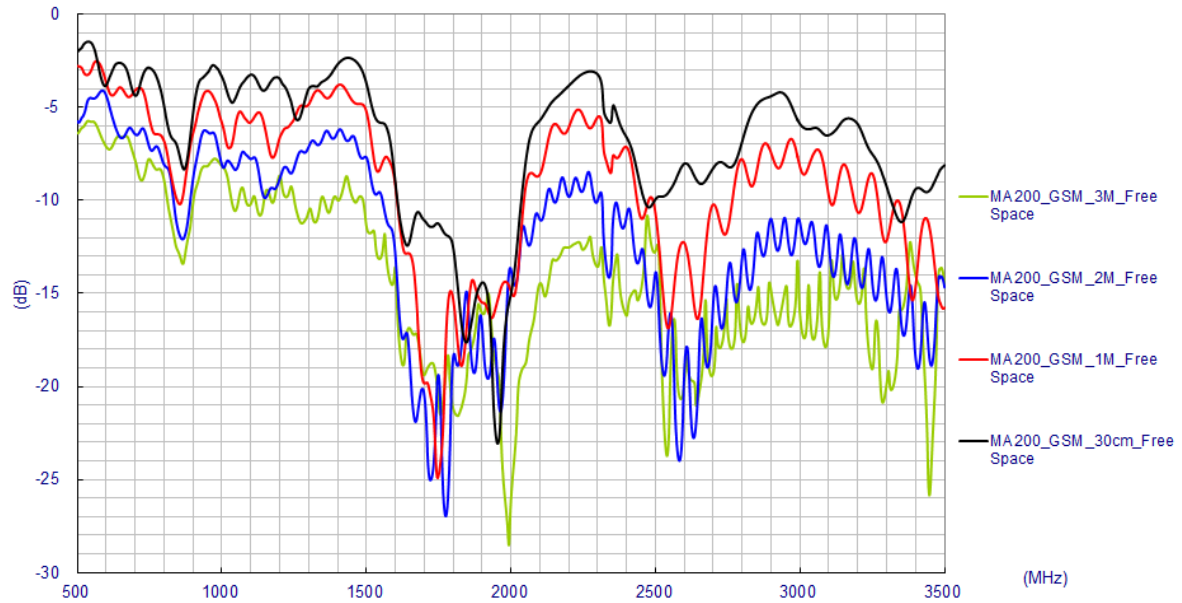

Free Space with RG174 Coaxial Cable

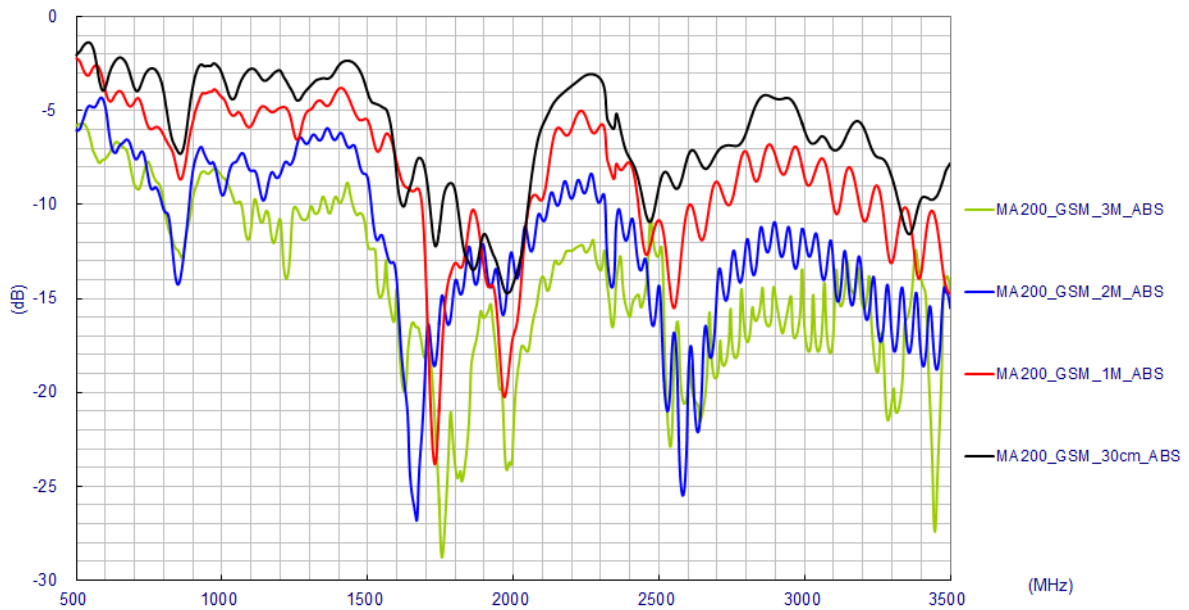

On 2mm thickness ABS Base with RG174 Coaxial Cable

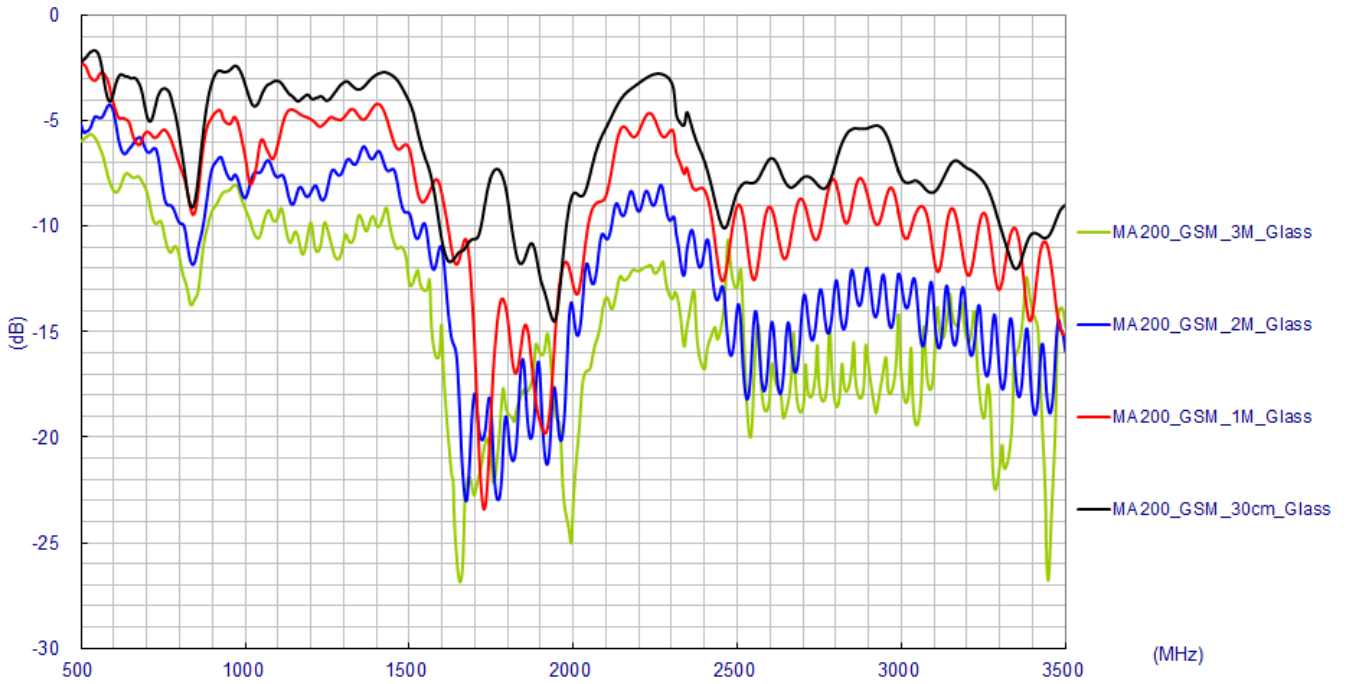

On Glass Base with RG174 Coaxial Cable

### 3.2. Efficiency

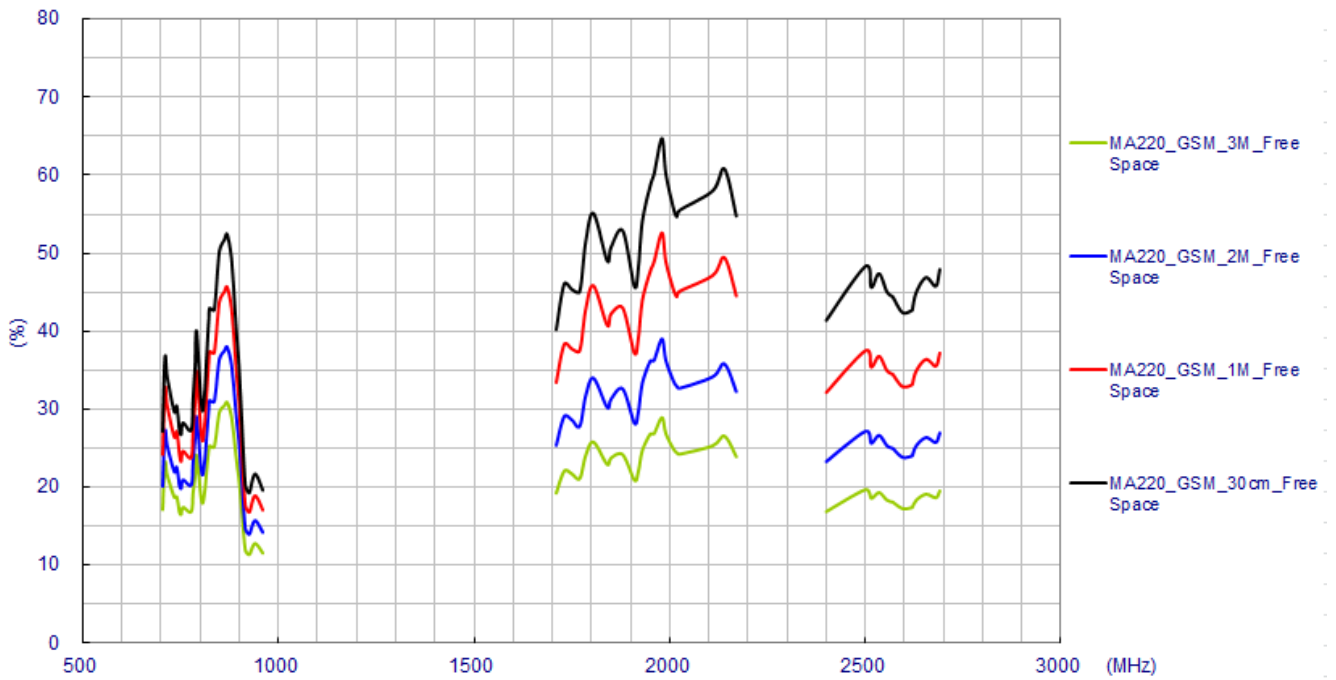

Free Space with RG174 Coaxial Cable

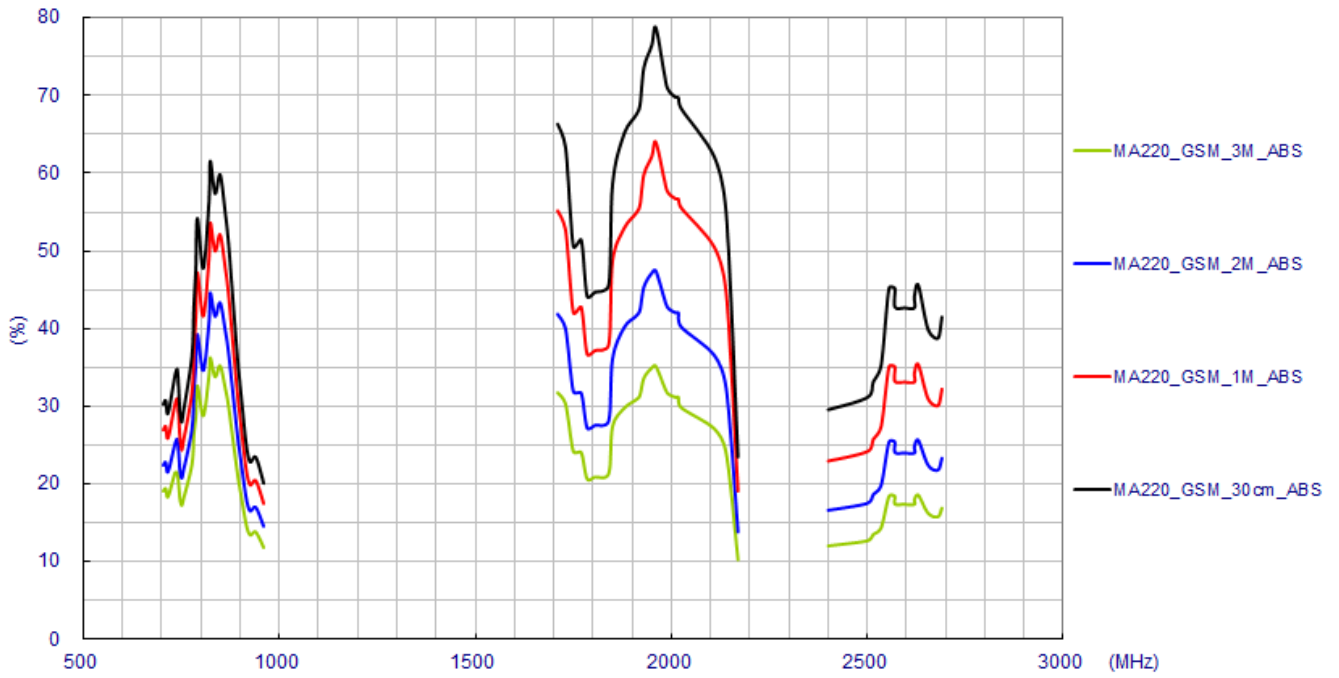

On 2mm thickness ABS Base with RG174 Coaxial Cable

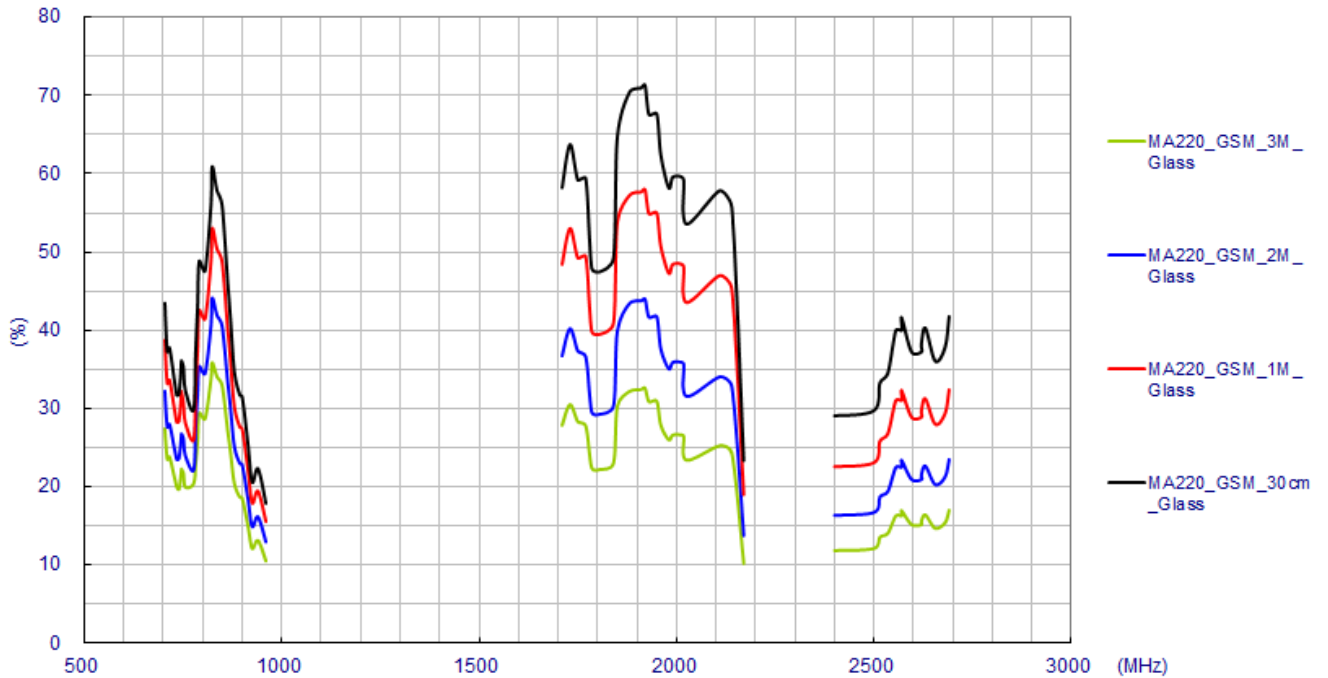

On Glass Base with RG174 Coaxial Cable



### 3.3. Peak Gain

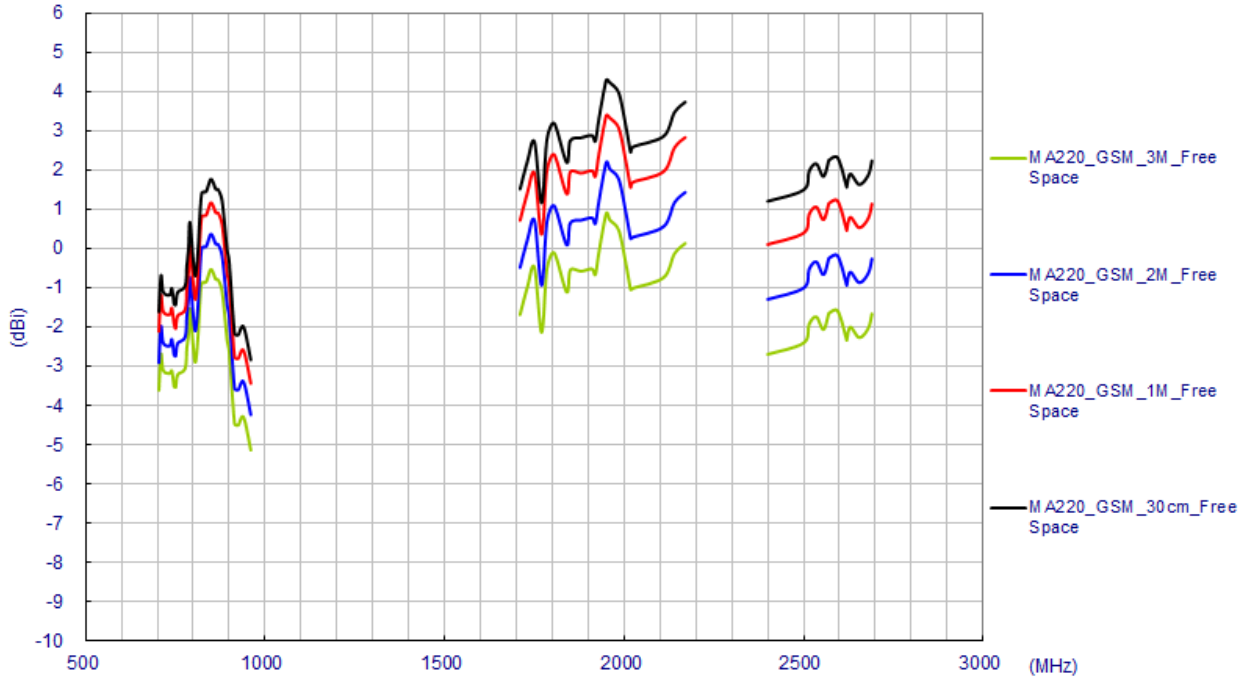

Free Space with RG174 Coaxial Cable

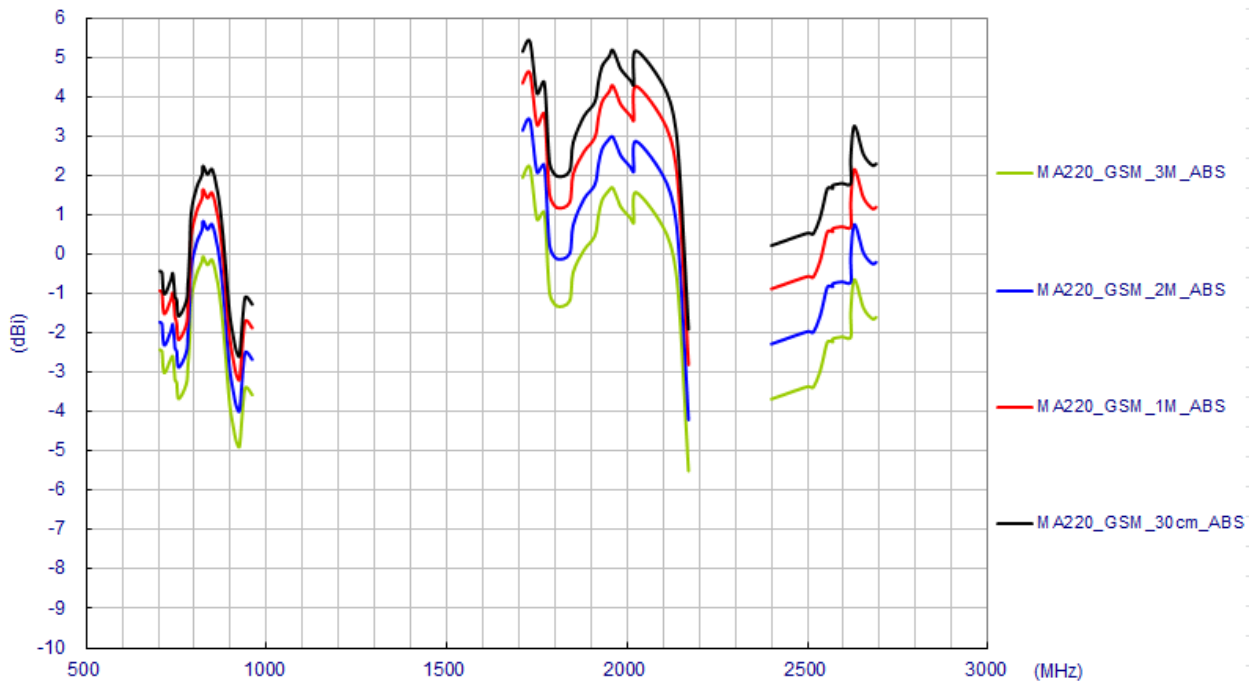

On 2mm thickness ABS Base with RG174 Coaxial Cable

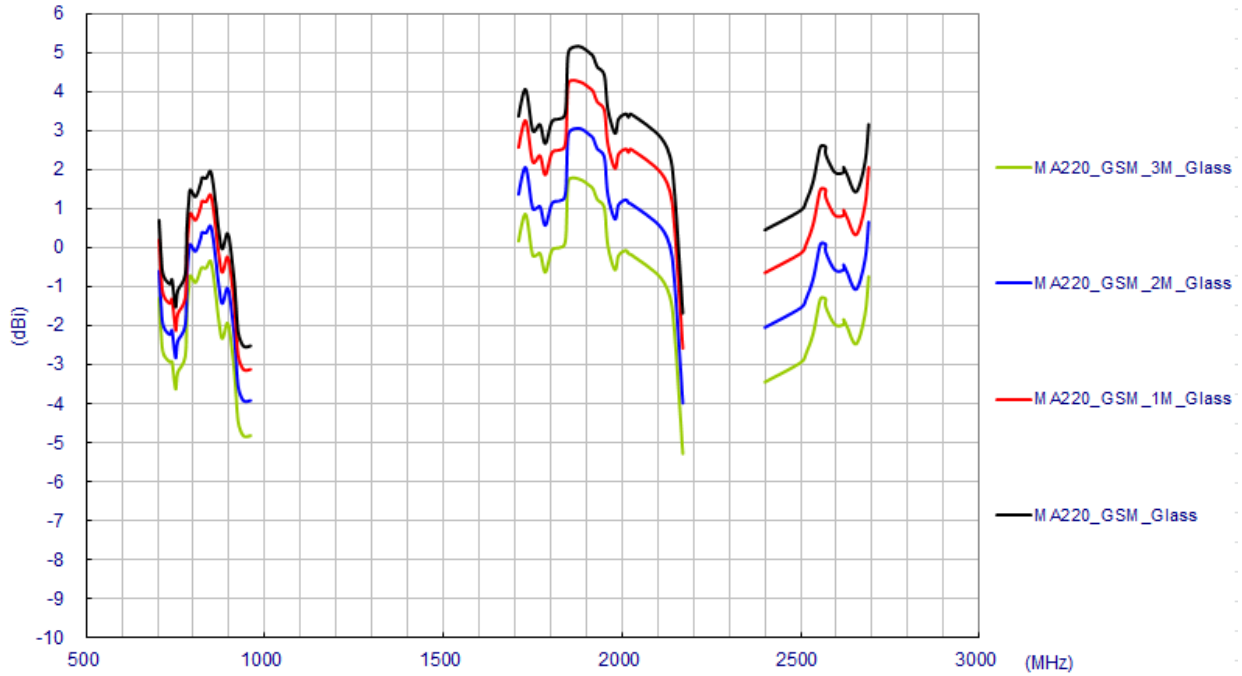

On Glass Base with RG174 Coaxial Cable

### 3.4. Average Gain

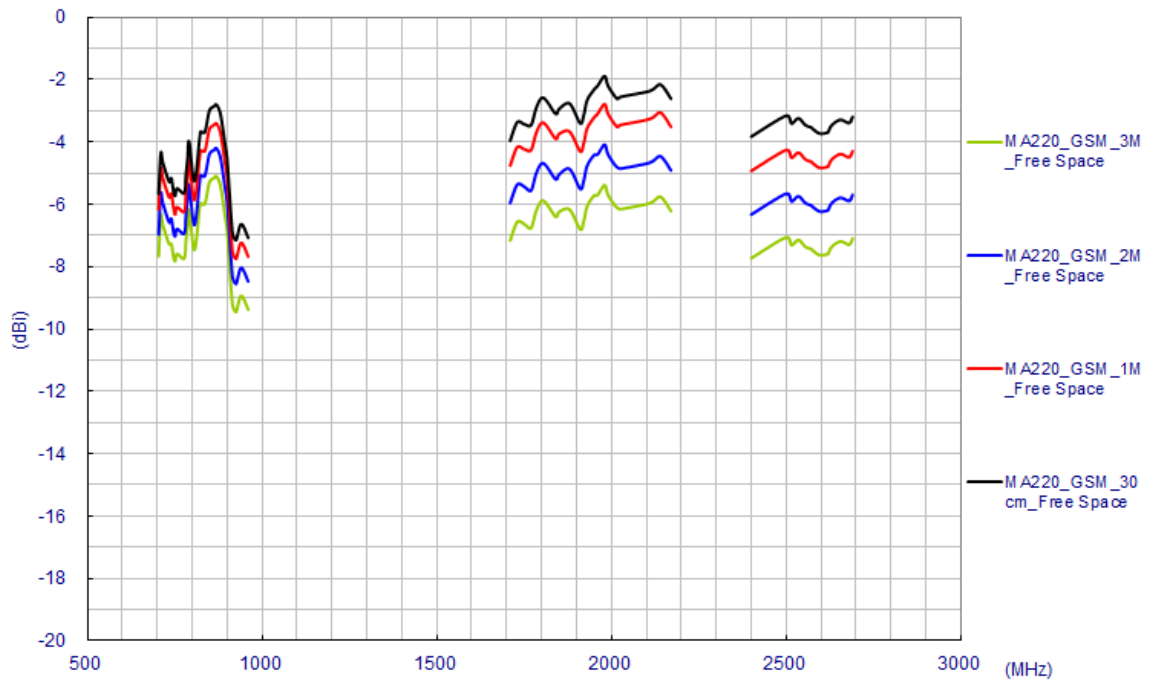

Free Space with RG174 Coaxial Cable

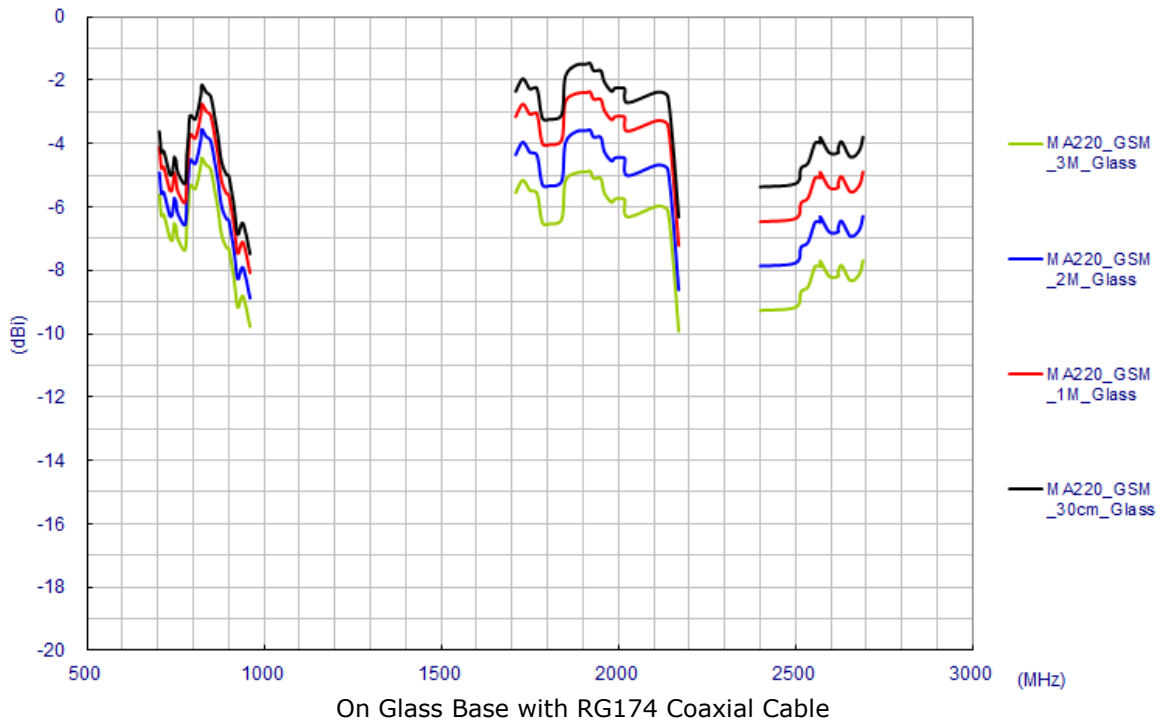
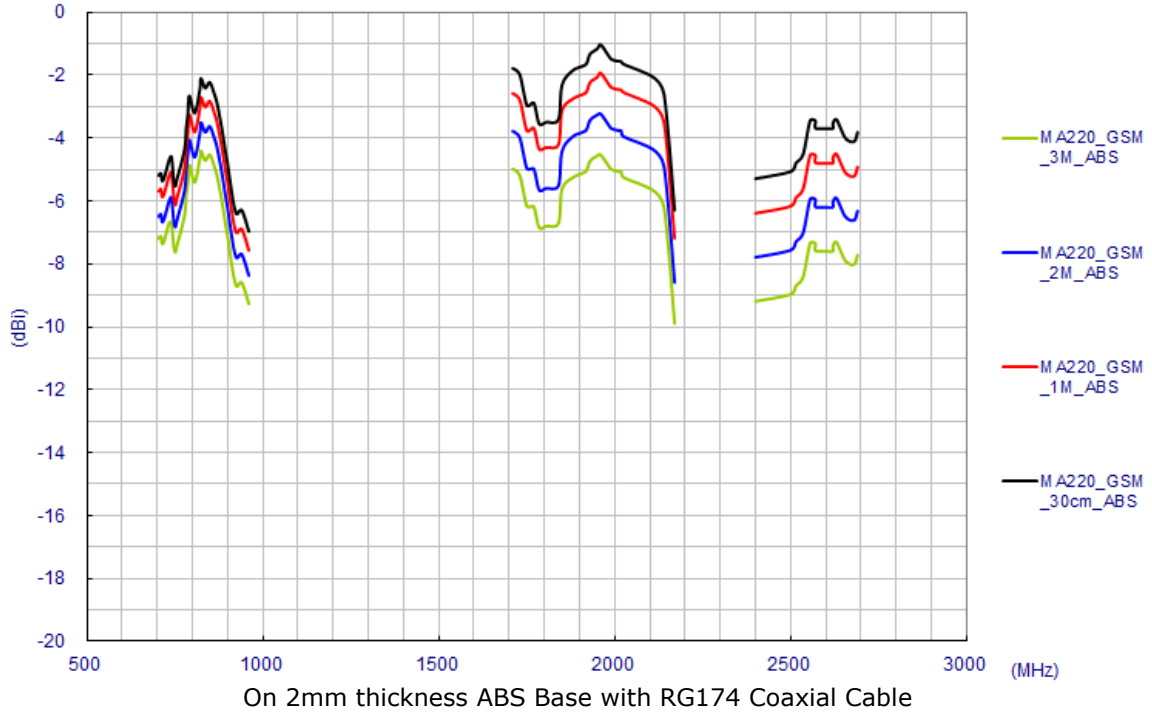

### 3.5. Free Space Radiation Pattern-3meter length cable



### XY Plane

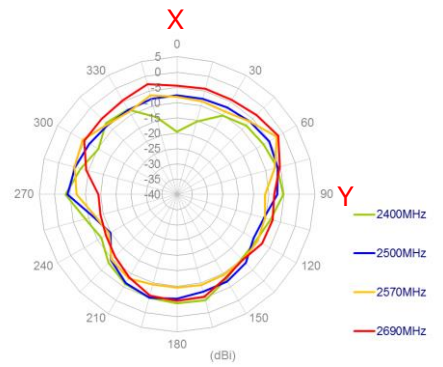
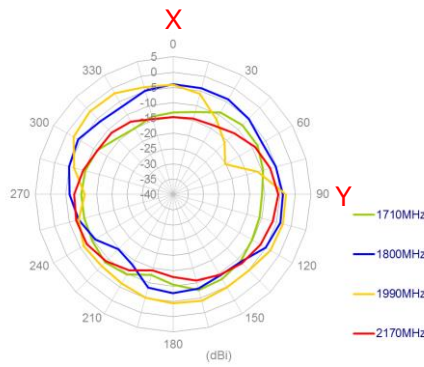
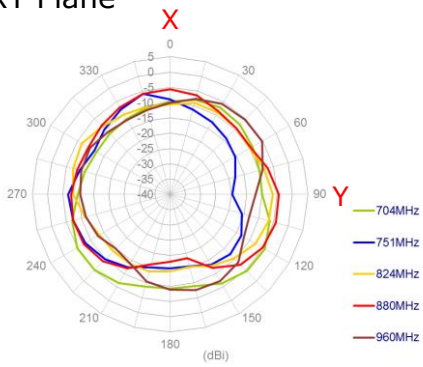

### XZ Plane

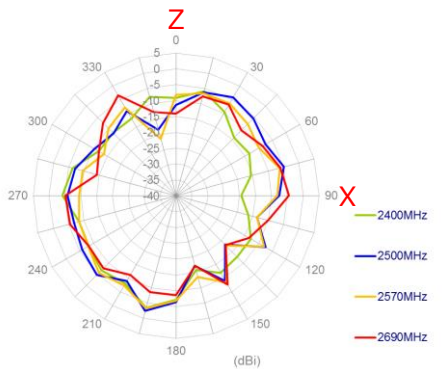
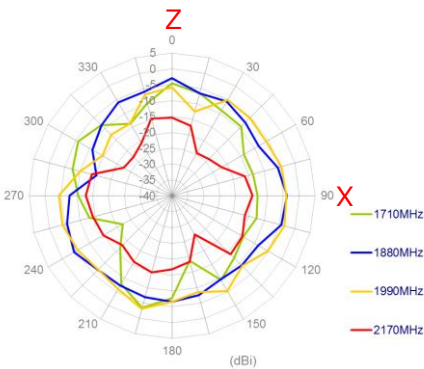
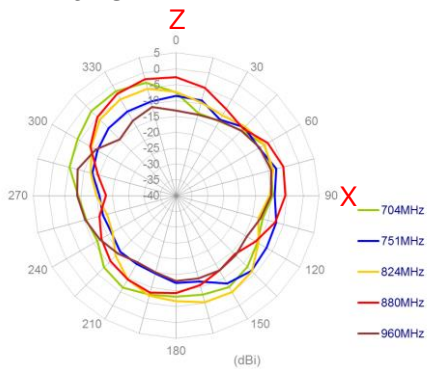

### YZ Plane

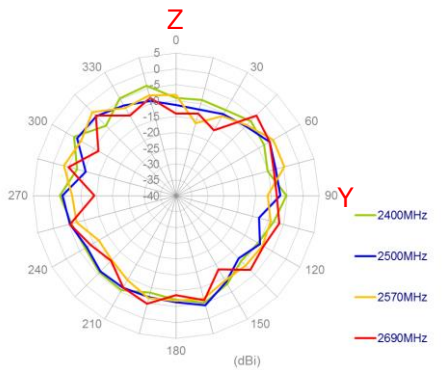
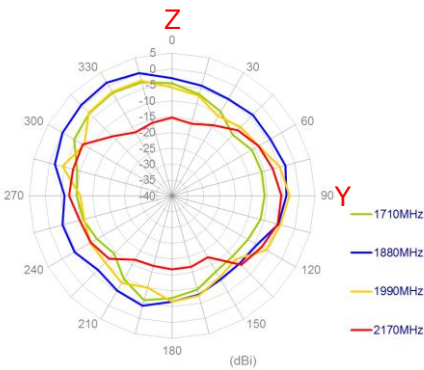
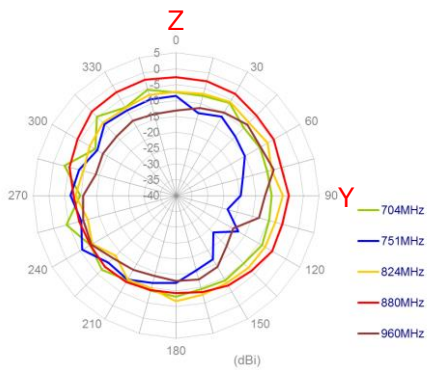

### 3.6. On 2mm thickness ABS Base Radiation Pattern-3meter length cable

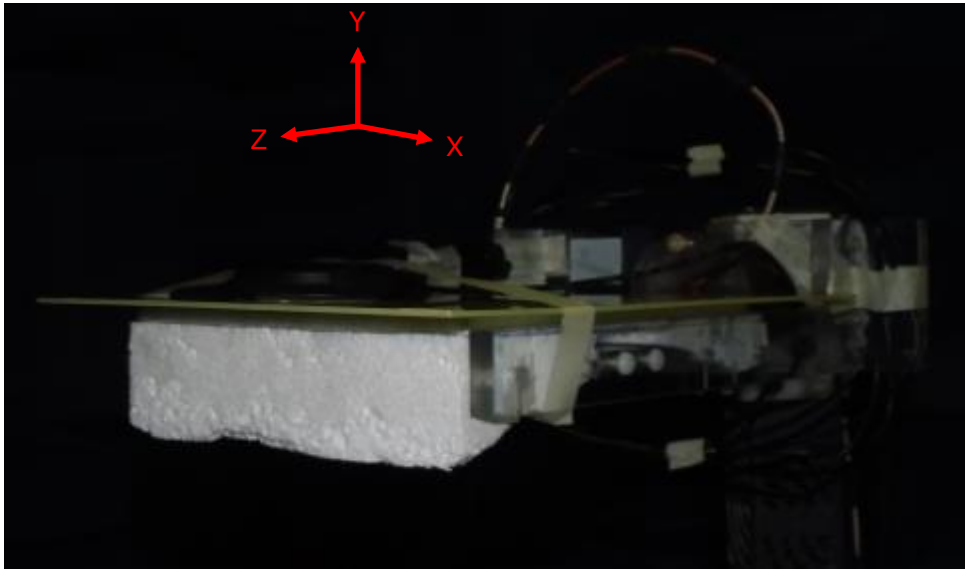

XY Plane

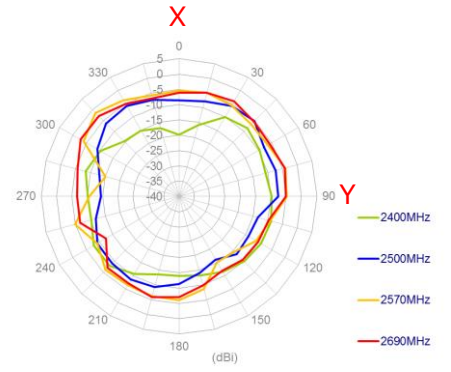
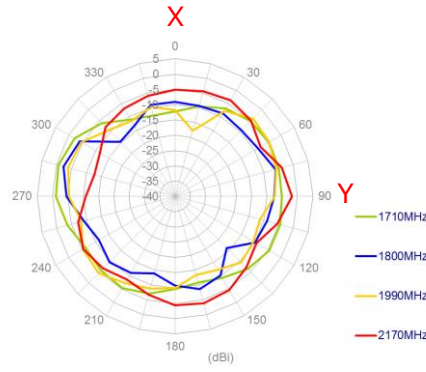
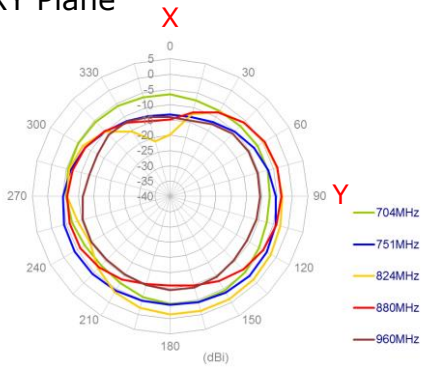

XZ Plane

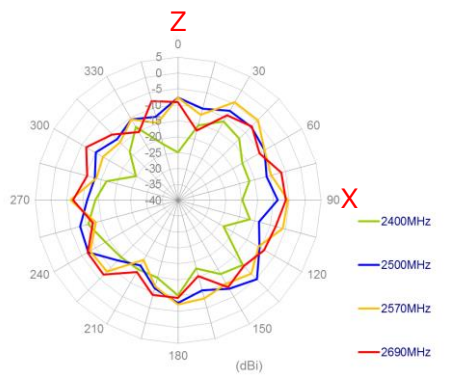
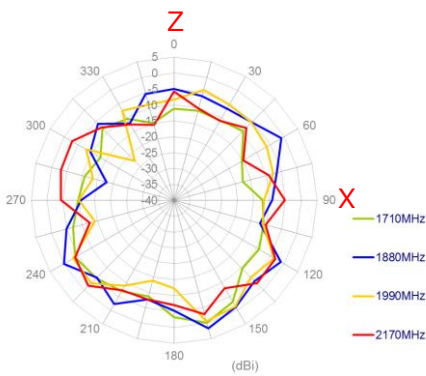
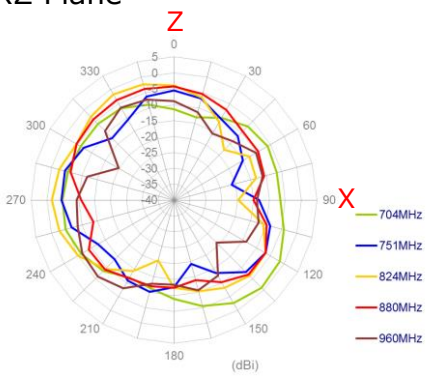

YZ Plane

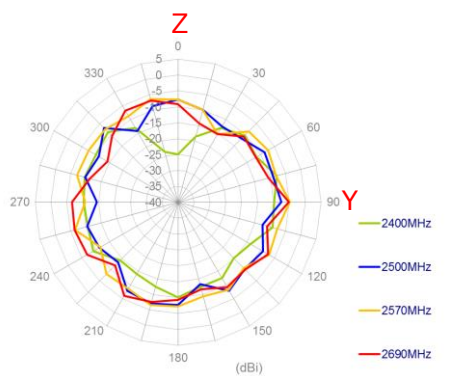
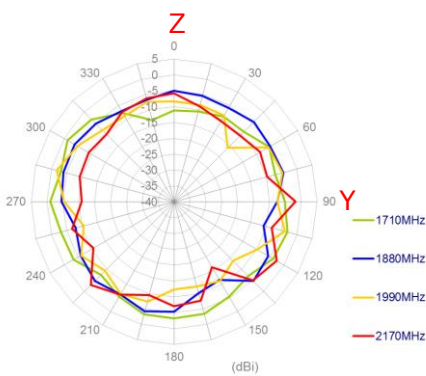
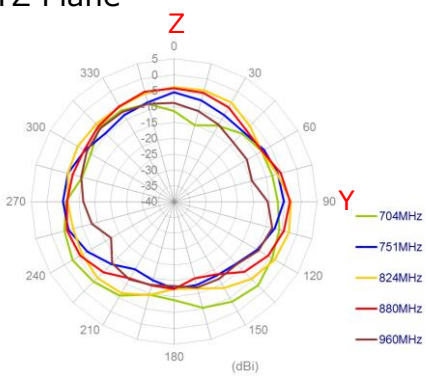

### 3.7. On Glass Base Radiation Pattern-3meter length cable

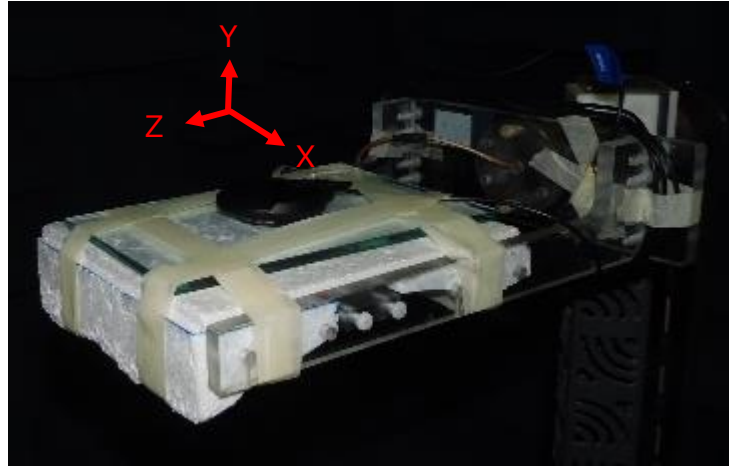



### XY Plane

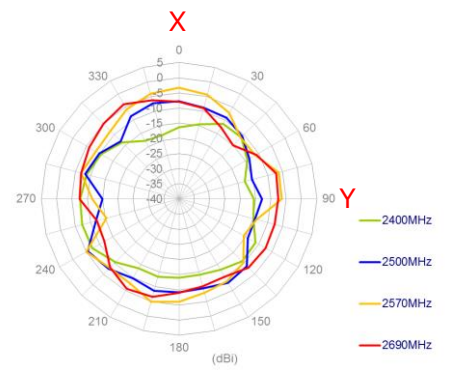
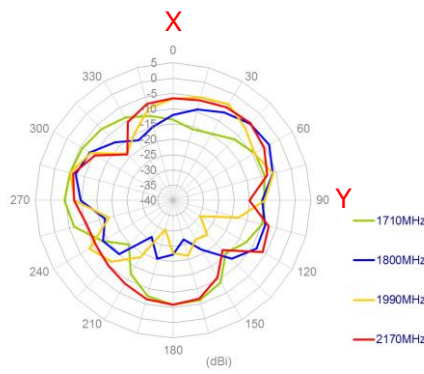
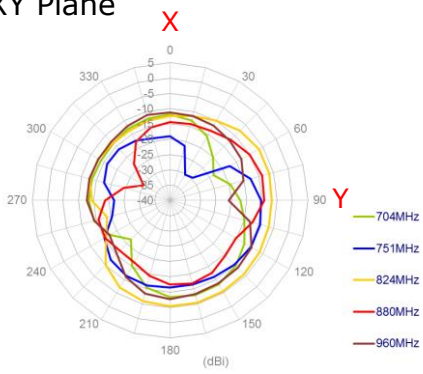

### XZ Plane

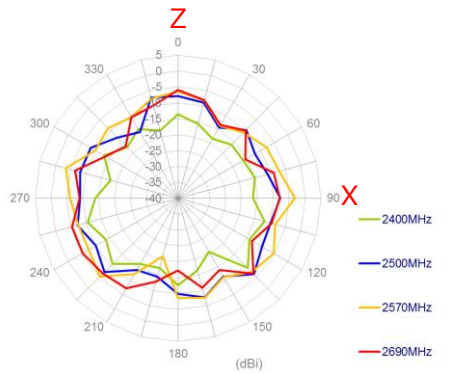
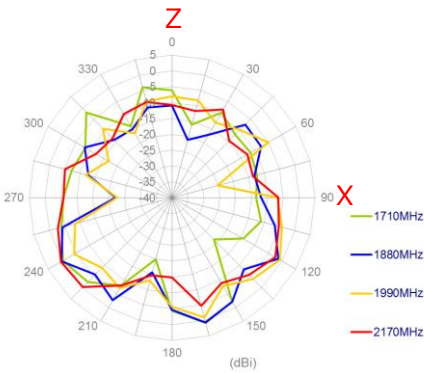
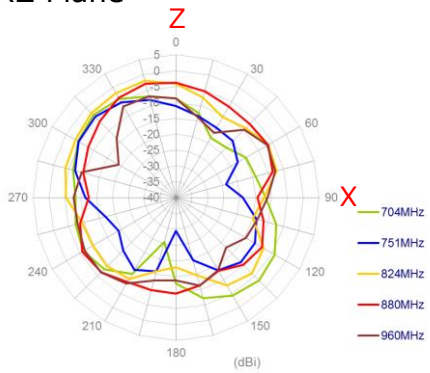

### YZ Plane

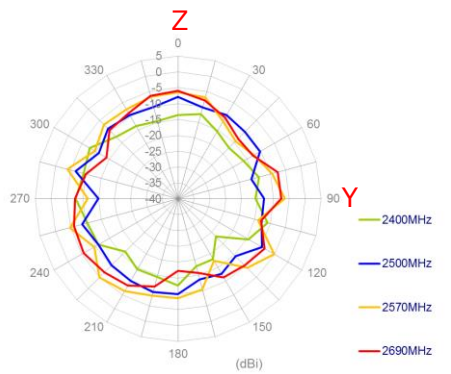
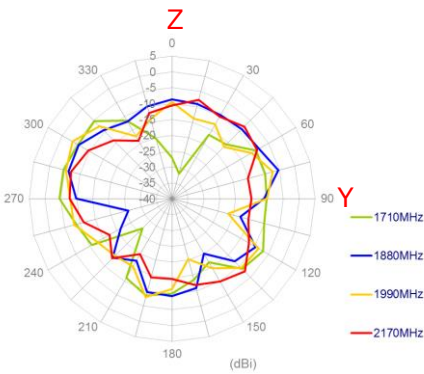
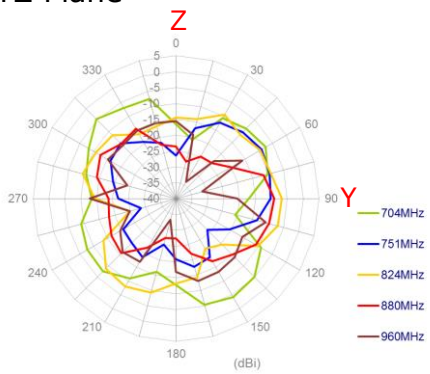

# 4. GPS-GLONASS-GALILEO Antenna Characteristics

## 4.1. Antenna Characteristics

### 4.1.1. Return Loss

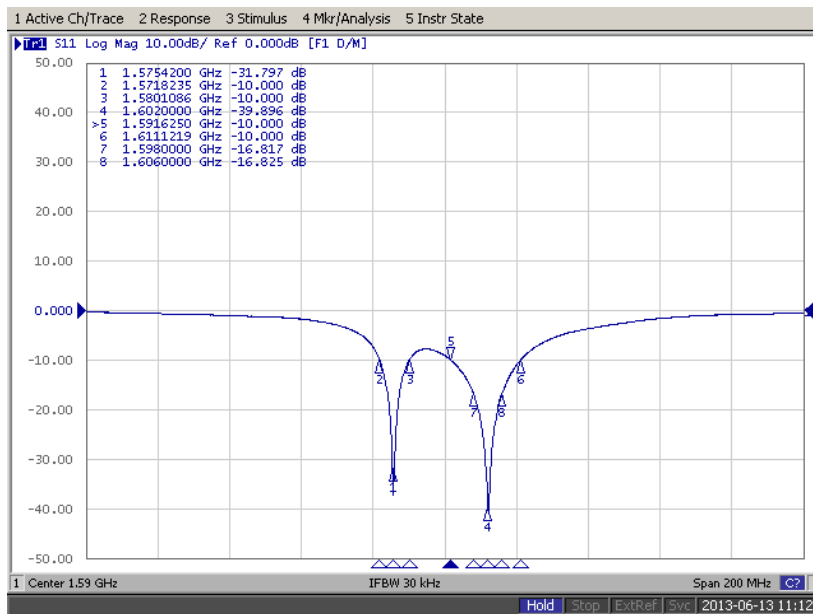

### 4.1.2. Smith Chart

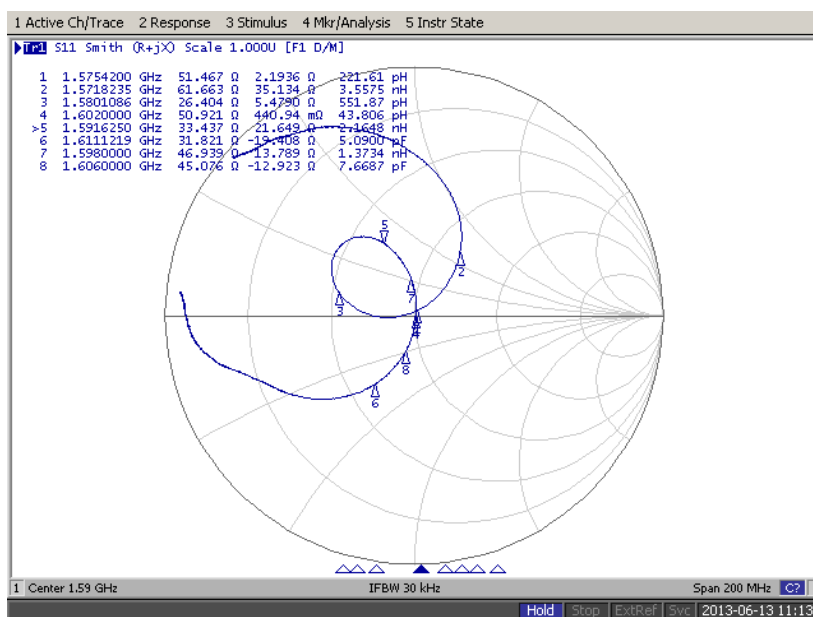

### 4.1.3. Experiment Results

Dimension (mm)	Fo(MHz)	Return Loss (dB)	Impedance( $\Omega$ )	Gain 0° H-Plane(dBic)	Gain 0° E-Plane(dBic)
25.0x25.0x4.0	1575.42	-31.7	51.4 + j 2.1	-0.08	0.00
	1598	-16.8	46.9 + j 13.7	-3.86	-3.62
	1602	-39.8	50.9 + j 0.4	-4.17	-4.32
	1606	-16.8	45.0 - j 12.9	-4.74	-5.16

### 4.1.4. Antenna Radiation Pattern

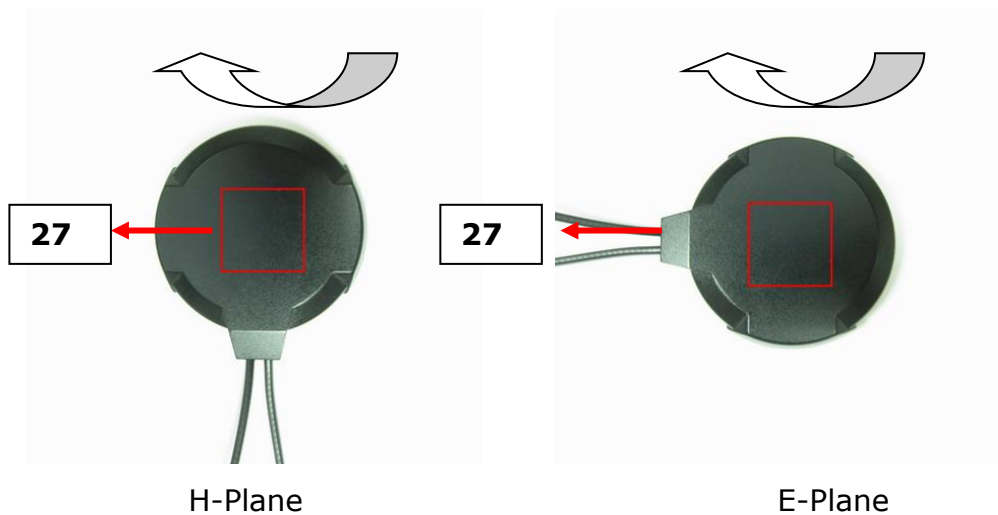

### 4.1.5. 1575.42 MHz

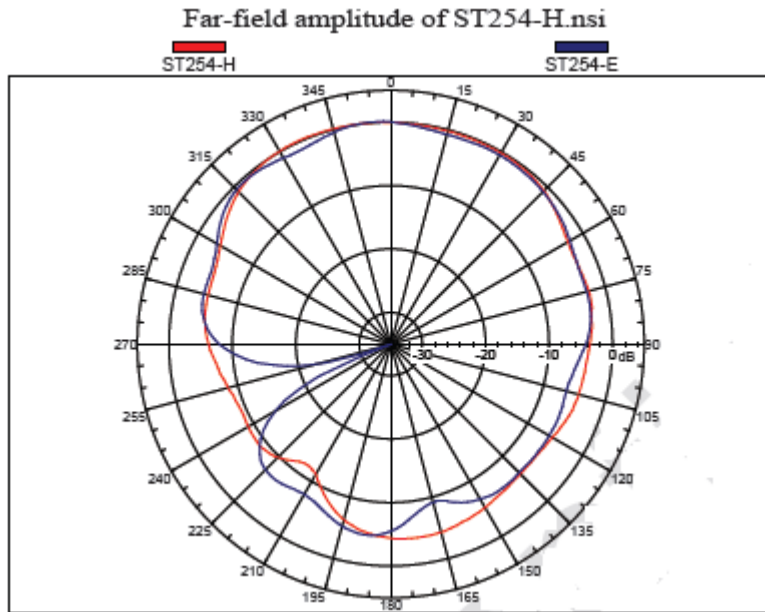

### 4.1.6. 1602 MHz

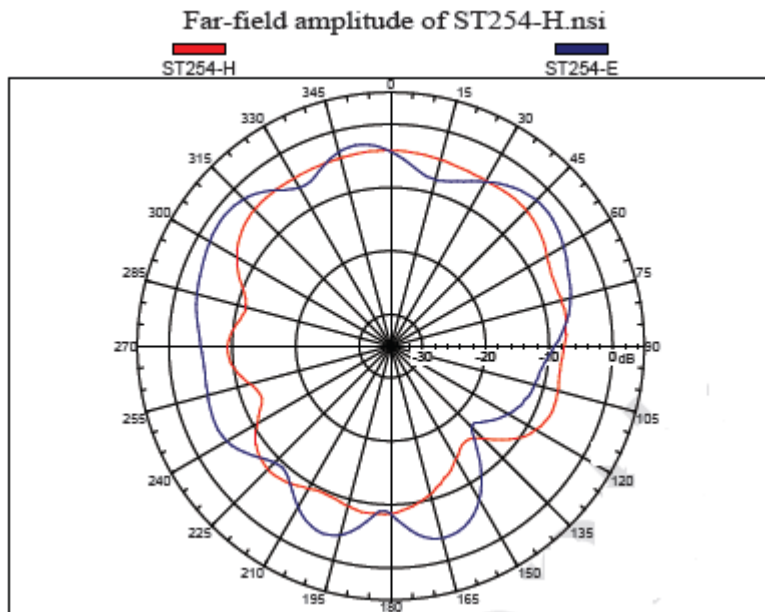

## 4.2. LNA Characteristics

### 4.2.1. S11

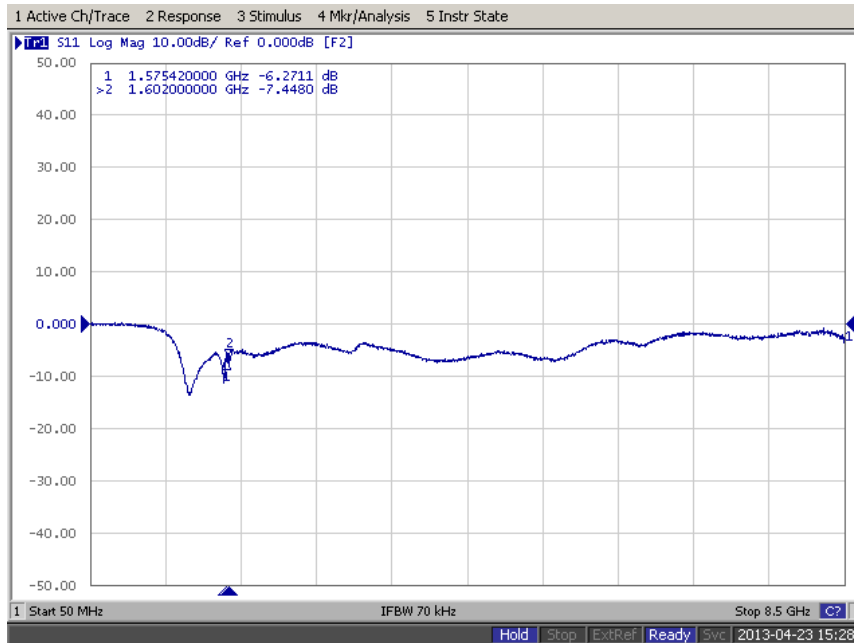

### 4.2.2. S12

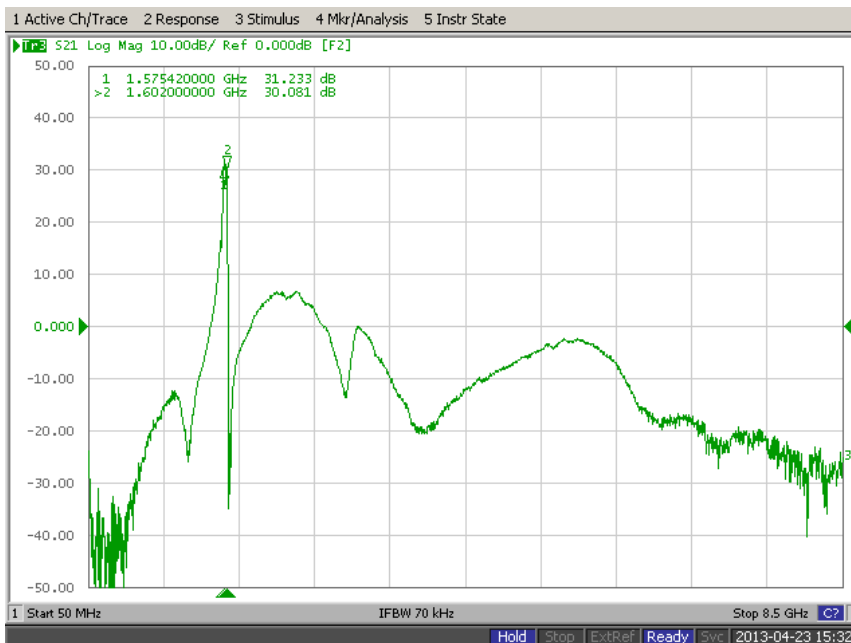

### 4.2.3. Noise Figure

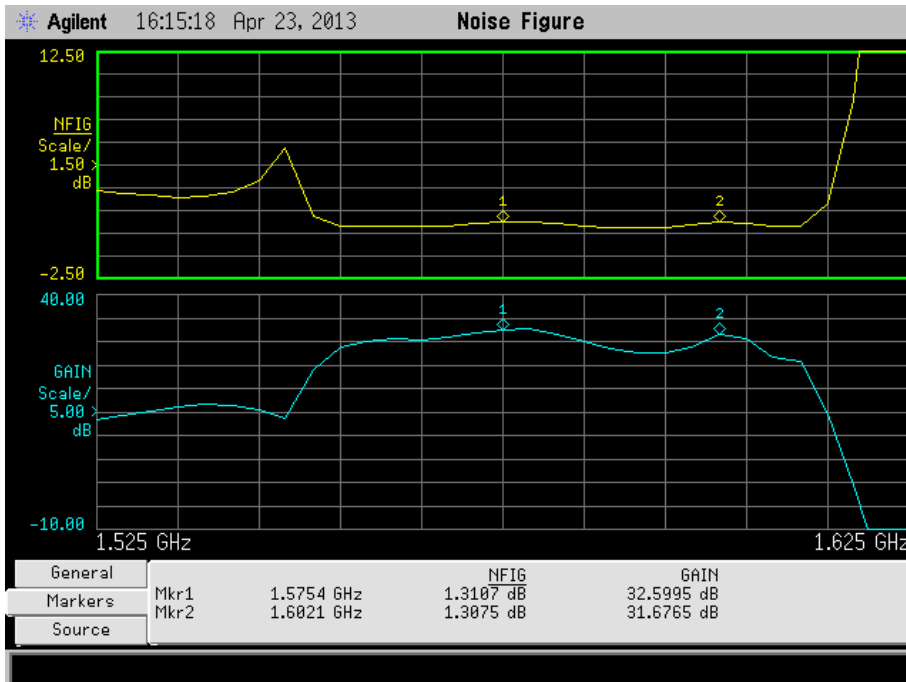

## 5. Drawing

### Top View

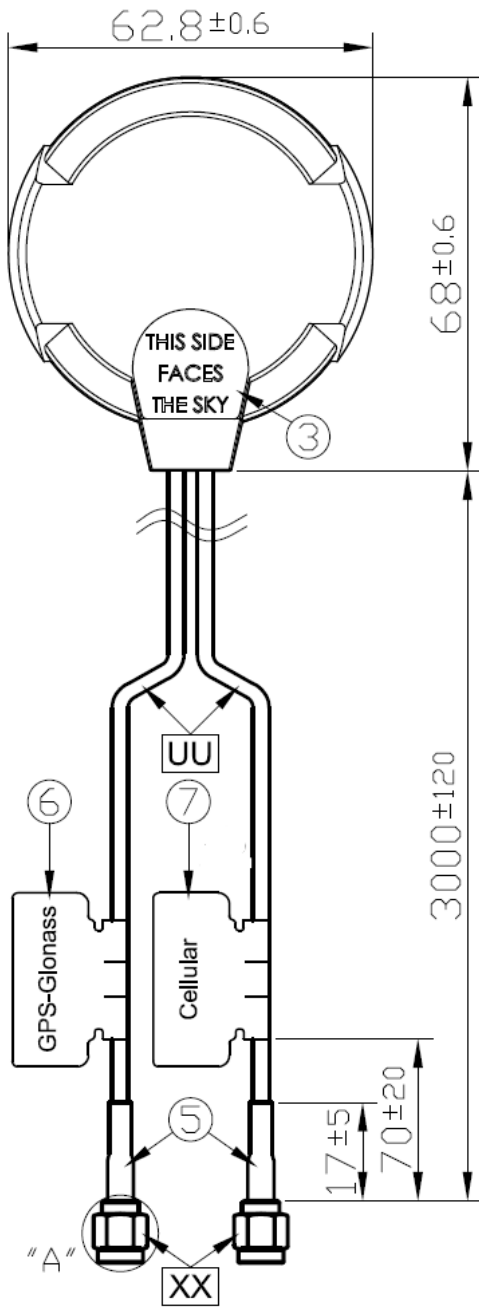

### Side View

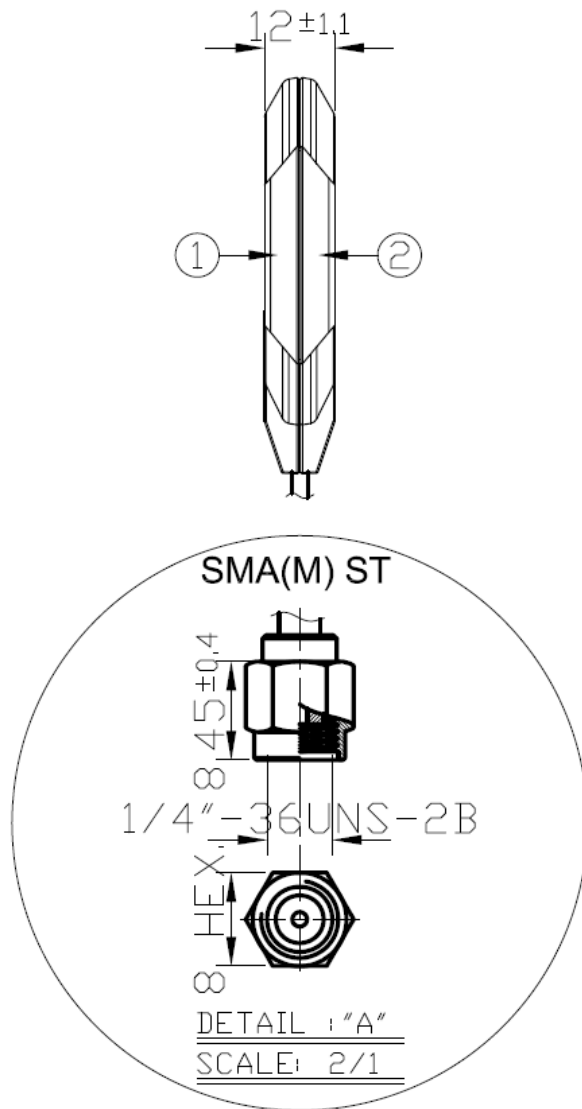

**Bottom View**

**Double sided 3M adhesive foam**

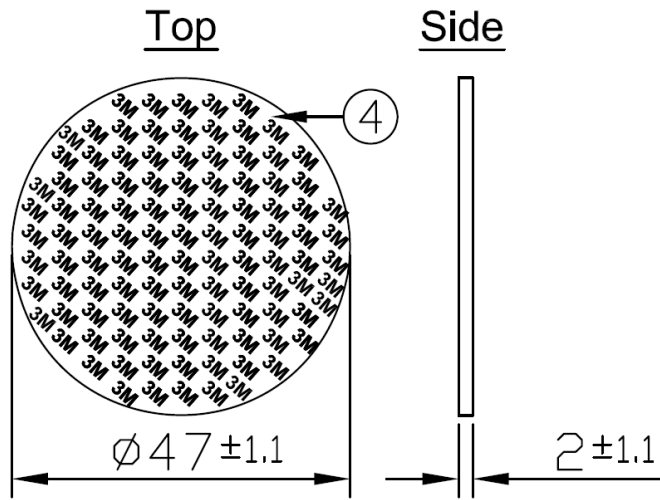
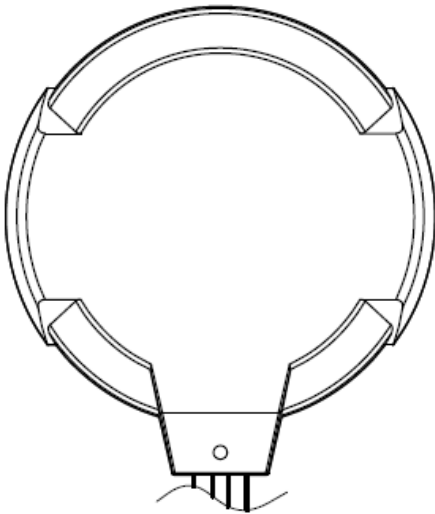

	Name	Material	Finish	QTY
1	Housing Top	ABS	Black	1
2	Housing Bottom	ABS	Black	1
3	Clear Label	PET	White	1
4	Double Adhesive Foam	3M 9448+CR-4305	Black	1
5	Heat Shrink Tube RG-174	PE	Black	2
6	GPS-Glonass Label	Coated Paper	Orange	1
7	Cellular Label	Coated Paper	Blue	1
	Name	Spec	Finish	QTY
UU	Cable Type	RG-174	Black	2
XX	Connector Type	SMA(M) ST	Gold	2



## 6. Packaging

1 pcs MA220.LB.001 per PE Bag  
 Bag Dimensions - 600 x 450 mm  
 Weight - 1200g

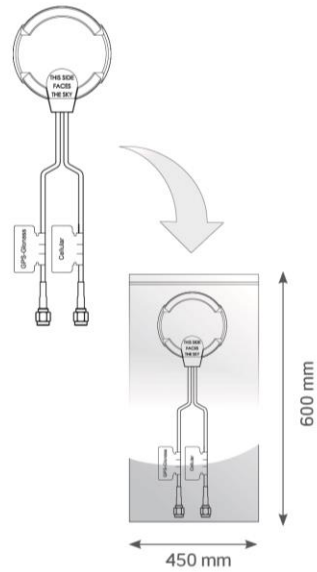

100 pcs MA220.LB.001 per carton  
 Carton - 730 x 390 x 250mm  
 Weight - 13.7Kg

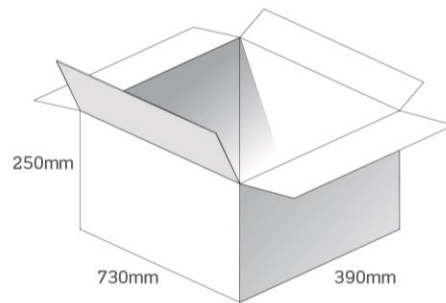

Pallet Dimensions 1200 x 1000 x 1450mm  
 12 Cartons per Pallet  
 4 Cartons per layer  
 5 Layers

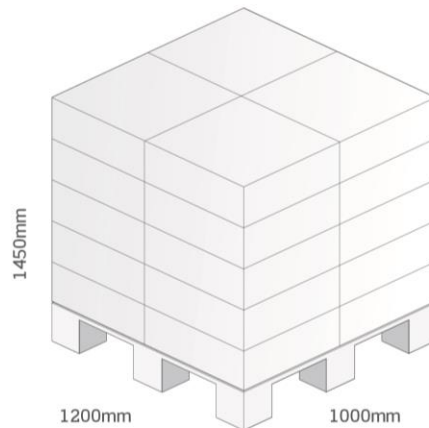

Taoglas makes no warranties based on the accuracy or completeness of the contents of this document and reserves the right to make changes to specifications and product descriptions at any time without notice. Taoglas reserves all rights to this document and the information contained herein.

Reproduction, use or disclosure to third parties without express permission is strictly prohibited.

Copyright © Taoglas Ltd.